

SPECTRA CAPSULE



The Spectra Light Capsules are powerful fluorescence exciters with focused light for uniform illumination and enhanced power. Equipped with primary and secondary optics, the Light Capsules are categorized as Laser Class II due to their intense power.



MULTISPECTRAL IMAGING



PULSE LIGHT



LASER CLASS II



NARROW BANDPASS FILTERS

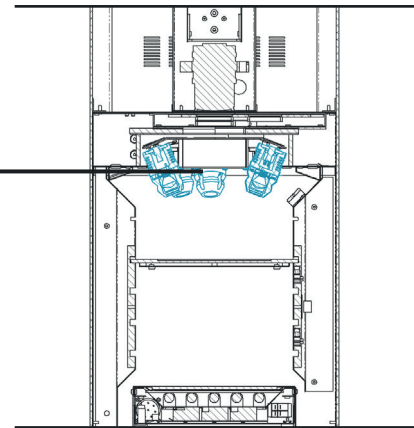
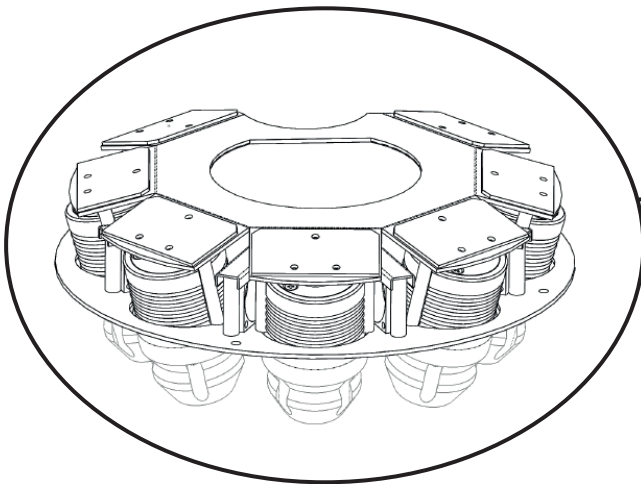

Exciter Capsules

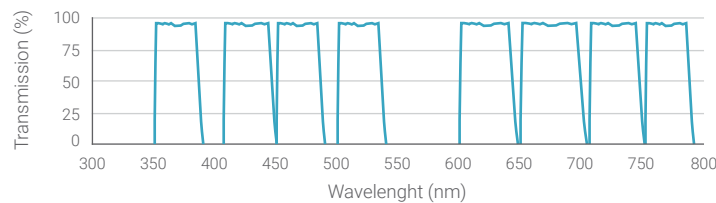

Chip material : AlGaInP, InGaN or AlGaAs
Filter blocking index: O.D. 5.5
Laser Class II

Emission Filters

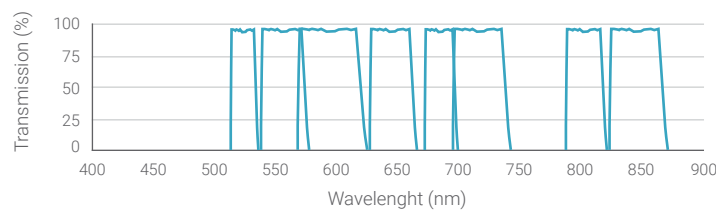

Focal disk for enhanced signal to noise ratio.
Sputtered magnetron technology.
Hard coated.

Achieve the desired narrow spectral bandwidth by selecting from our set of Capsules or by customizing your own light spectrum.



Optimum Results - Primary and Secondary Optics Increase Sensitivity and Homogeneity.



The LED Light Capsules for quantitative fluorescence

Benefit from an excellent signal-background ratio for imaging and detect the lowest protein concentration. Choose from 8 LED Light Capsules to cover the complete standard spectrum from UV to infra-red.

Each Capsule produces a monochromatic light of a different wavelength with a very narrow-band illumination.

This reduces the cross-stimulation and increases the sensitivity of your images.

From 400 to 700nm, custom design your own Light Capsule to get closer from the spectrum of your dye.

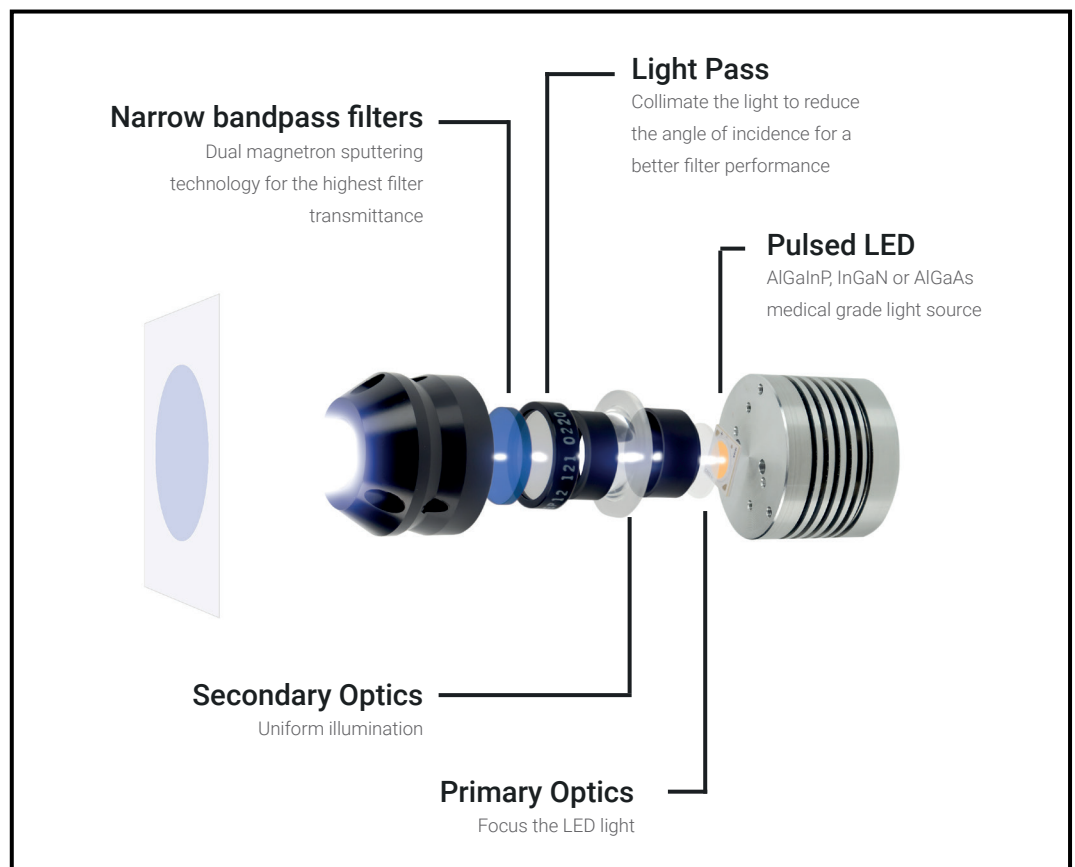

The Spectra Light Capsules offers proven reliability and superior performance.

CAPSULE OF LIGHT SPECTRUM

780nm

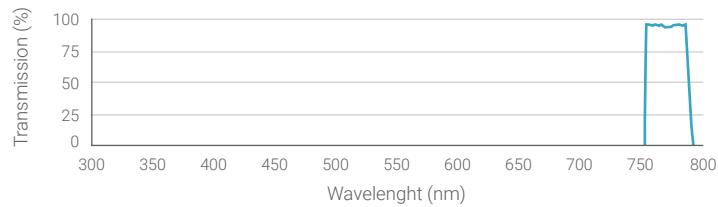

Peak wavelength : 780nm
Chip material : AlGaAs
Blocking index: O.D. 5.5
Laser Class II

740nm

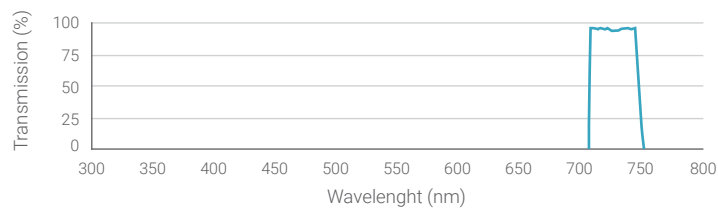

Peak wavelength : 740nm
Chip material : AlGaAs
Blocking index: O.D. 5.5
Laser Class II

680nm

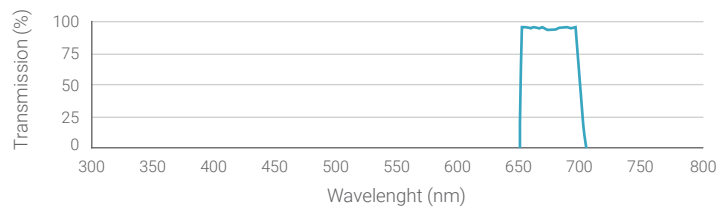

Peak wavelength : 680nm
Chip material : AlGaInP
Blocking index: O.D. 5.5
Laser Class II

640nm

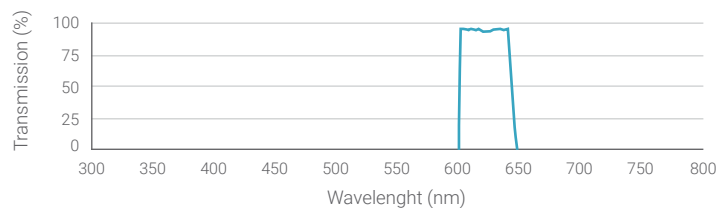

Peak wavelength : 640nm
Chip material : AlGaInP
Blocking index: O.D. 5.5
Laser Class II

Spectrum and peak values may differ slightly from the typical values and spectrum above.

Our standard range of 8 Light Capsules allow you a wide variety of possible applications in the UV, the visible and the IR ranges.

CAPSULE OF LIGHT SPECTRUM

530nm

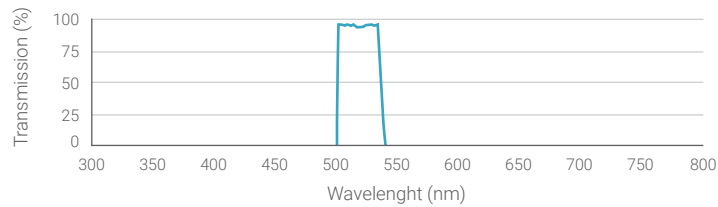

Peak wavelength : 530nm
Chip material : AlGaInP
Blocking index: O.D. 5.5
Laser Class II

480nm

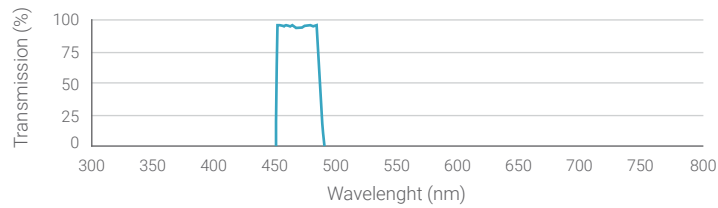

Peak wavelength : 480nm
Chip material : AlGaInP
Blocking index: O.D. 5.5
Laser Class II

440nm

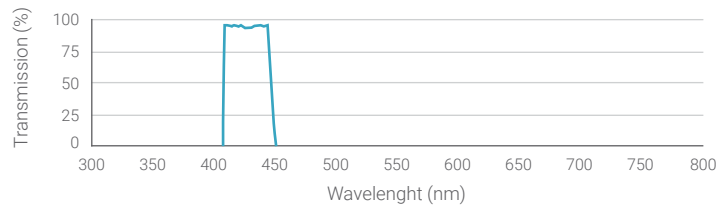

Peak wavelength : 440nm
Chip material : AlGaInP
Blocking index: O.D. 5.5
Laser Class II

365nm

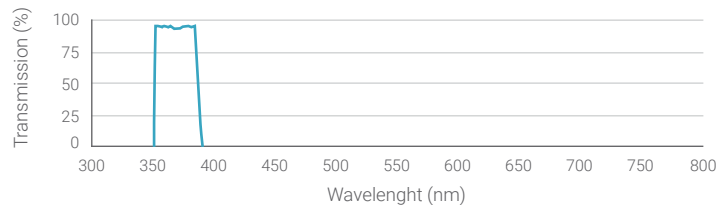

Peak wavelength : 365nm
Chip material : InGaN
Blocking index: O.D. 5.5
Laser Class II

Spectrum and peak values may differ slightly from the typical values and spectrum above.

Our filter combines the most sophisticated ion-beam-sputtering deposition systems, with our proprietary aperture disk for enhanced signal to noise ratio.

EMISSION FILTER SPECTRUM

F-850

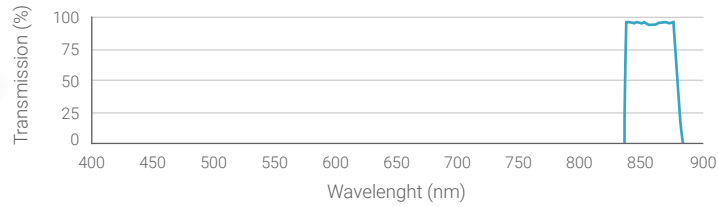

Typical Range: 830-870nm
Sputtered magnetron technology.
Hard coated.

F-800

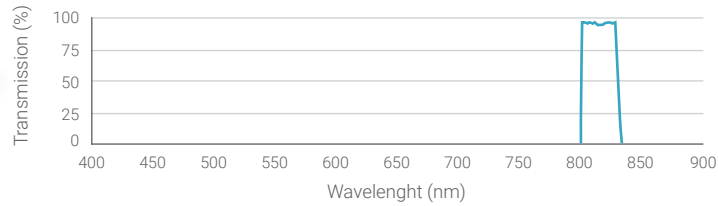

Typical Range: 800-840nm
Sputtered magnetron technology.
Hard coated.

F-750

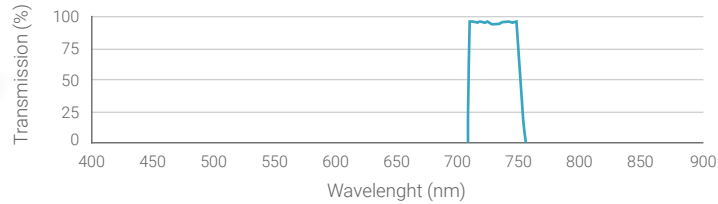

Typical Range: 710-760nm
Sputtered magnetron technology.
Hard coated.

F-700

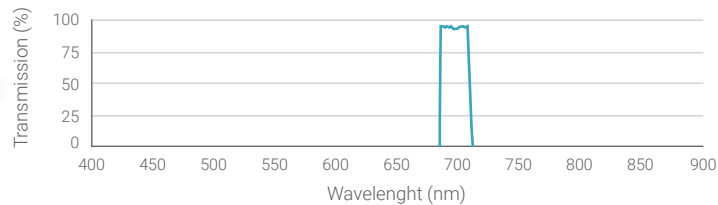

Typical Range: 690-720nm
Sputtered magnetron technology.
Hard coated.

Spectrum and peak values may differ slightly from the typical values and spectrum above.

Steeper edges, precise wavelength accuracy, and carefully optimized blocking mean better contrast and faster measurements.

EMISSION FILTER SPECTRUM

F-650

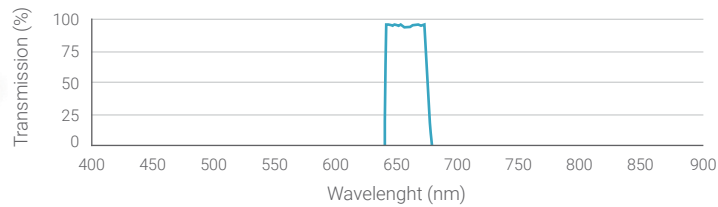

Typical Range: 640-670nm
Sputtered magnetron technology.
Hard coated.

F-600

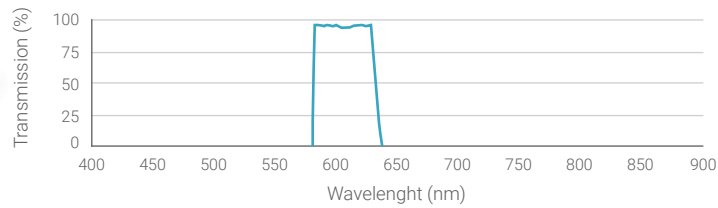

Typical Range: 580-640nm
Sputtered magnetron technology.
Hard coated.

F-550

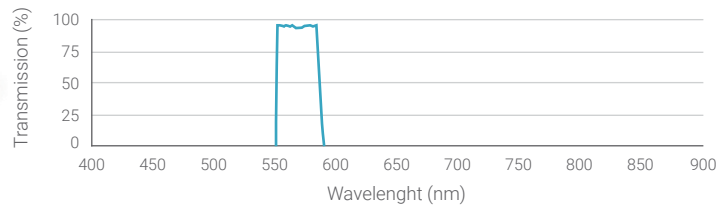

Typical Range: 550-580nm
Sputtered magnetron technology.
Hard coated.

F-500

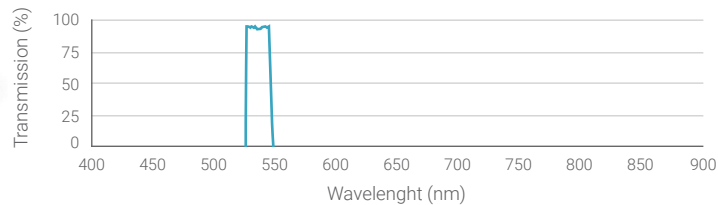

Typical Range: 530-550nm
Sputtered magnetron technology.
Hard coated.

Spectrum and peak values may differ slightly from the typical values and spectrum above.