

Predictive Discovery  
Precision Diagnostics



Cellular Analysis  
**BIOFLUX**

BIOFLUX



# Combining the Convenience of a Well Plate with the Physiological Relevance of Shear Flow

Many physiological processes take place under flow conditions: blood flowing through the vasculature; cancer cells circulating throughout the body; plaque forming on teeth under the presence of saliva flow. It is now well established that physiological flow has a profound impact on many biological studies, yet much research is still conducted *in vitro* without the presence of flow.

BioFlux from Fluxion Biosciences gives you the ability to introduce flow to your research and drug discovery experiments, effectively emulating *in vivo* conditions and revealing the true biology. The microfluidic well plate format opens up a multitude of experiments which could never be done in static well plates.



## Shear flow is a critical physiological factor in many areas of biology and drug discovery

*“Given the critical role of shear in regulating platelet adhesion and thrombus growth, these findings may have potential pathophysiological significance.”*

Jackson, et al.  
Arterioscler. Thromb. Vasc. Biol.26;663-669

## THE POWER OF FLOW

Now you don't have to choose between high-throughput well plate assays and highly-functional flow cell experiments. BioFlux offers the physiological relevance of laminar flow chambers with the throughput and convenience of standard well plates, allowing for a wide variety of cell-based assays.

**Microbiology**

**Vascular biology**

**Platelets and cardiovascular disorders**

**Immunology**

**Stem cells and developmental biology**

**Oncology**

Shear stress plays an important role in creating physiologically-relevant models to answer fundamental questions in cellular biology. In drug discovery and development, BioFlux helps ensure that only the most promising compounds will be passed through to clinical trials, saving tremendous time and expense versus conventional screening methods.

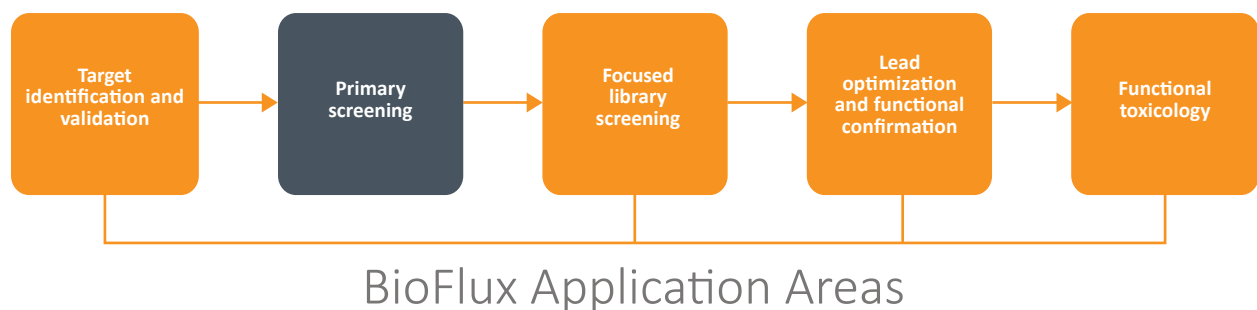

# FEATURES

BioFlux provides the highest degree of shear control for cellular analysis assays. With automated experimental control, multiplexing up to 96 simultaneous experiments, and sophisticated data analysis software simplifying and accelerating complex functional assays, large projects can be effectively reduced from months to days. The well plate microfluidic design improves reliability and reproducibility while enabling precise control of critical parameters. While BioFlux One and BioFlux 200 can be integrated with nearly any inverted microscope, BioFlux 1000z and BioFlux DCIS both include a high resolution microscope perfect for capturing quality data.

High throughput platform with up to **96 flow cell assays run in parallel**

Bridging the gap between in vitro and in vivo experiments with controlled, **physiological shear flow** up to  $200 \text{ dyne/cm}^2$

Well plate simplicity – standard format, pre-sterilized, no tubing to change

Glass bottom plates for **superior imaging quality** or custom options for more **complex experimentation**

**Capability for two-phase flow, alternative gas (hypoxia, etc.), dual gas, and temperature-controlled experiments**

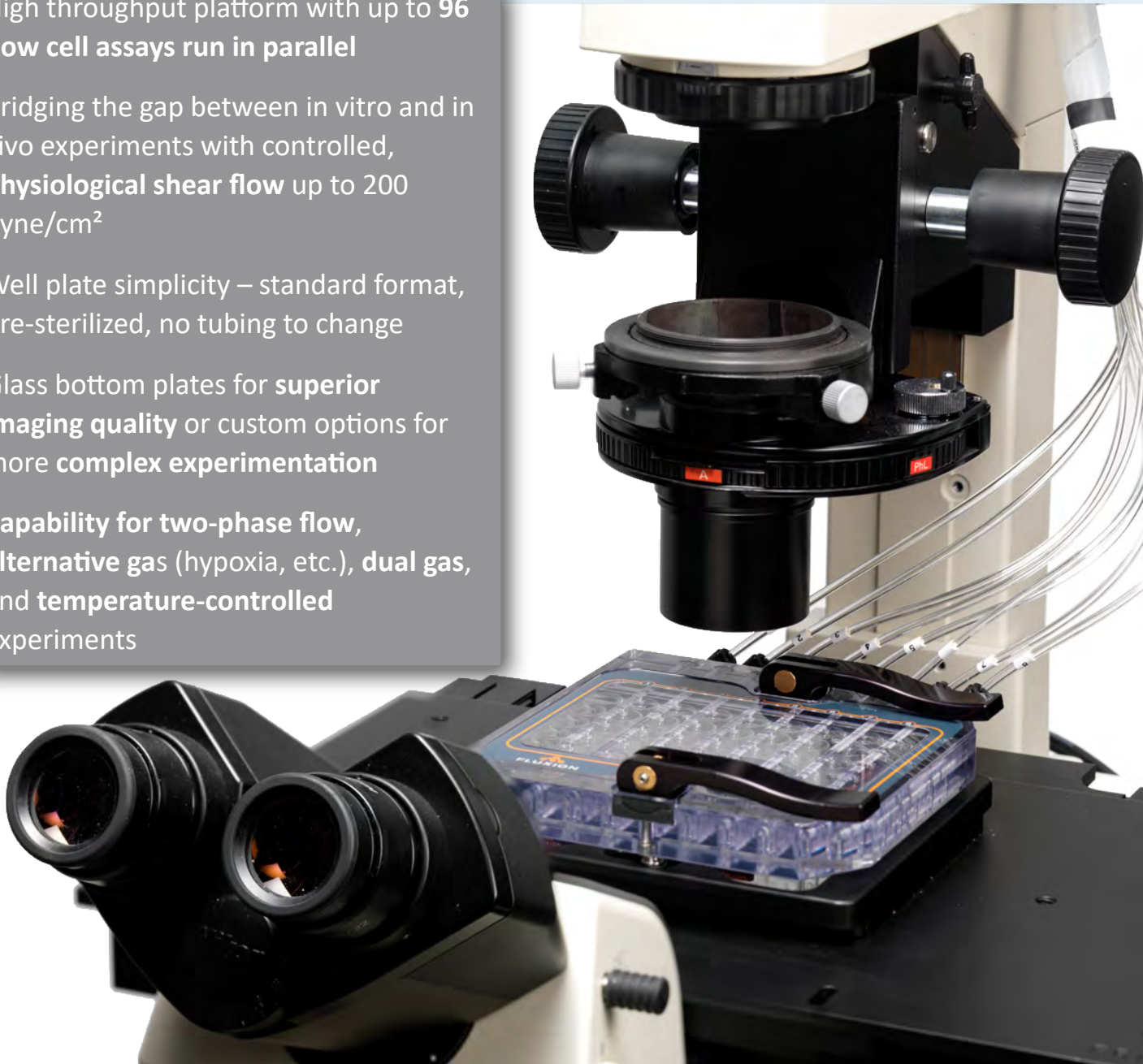

# PLATES WITH INTEGRATED FLOW

BioFlux utilizes the innovative Well Plate Microfluidic™ technology to embed micron-scale fluidic channels on the bottom of a standard well plate. By controlling the flow across the experimental channel, you can simulate a wide range of physiological conditions. Using the well plate format ensures that the experimental setup and image acquisition fit right into your existing workflow.

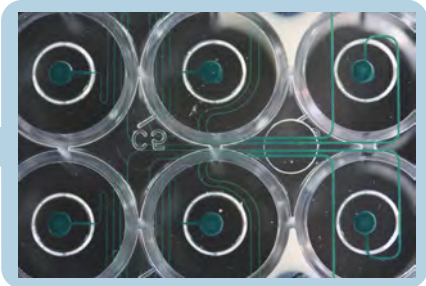

View from underneath the 48-well plate.

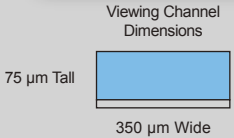
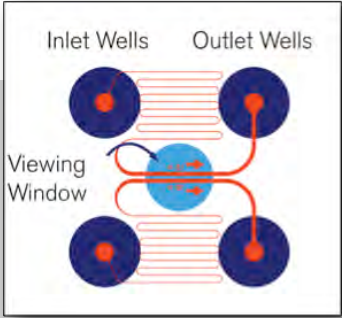
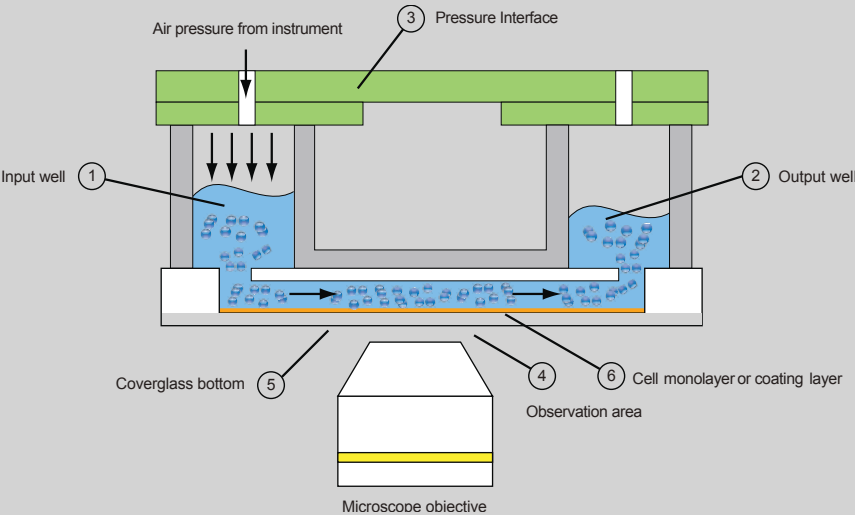

BioFlux plates are arrays of microfluidic flow cells embedded at the bottom of standard format well plates. The BioFlux pressure interface couples to the top of the well plate and applies a controlled pneumatic pressure from the controller to the top of the wells. This drives the fluid through the channels at a user-defined flow rate. Due to the positive air pressure delivered by the interface, we remove the need to have fluid-filled tubing and syringes that are typically needed to feed these flow experiments. Instead, the whole experiment happens within the plate.

# MICROFLUIDIC CONFIGURATIONS

## 48-Well Low Shear Plate

The 48-well low shear plate can run up to 20 dyne/cm<sup>2</sup>. With one inlet well and one outlet well per experimental channel, up to 24 assays can be run on one plate. The high number of experimental channels makes it ideally suited for testing larger sets of conditions, such as compound screening or genetic variants.

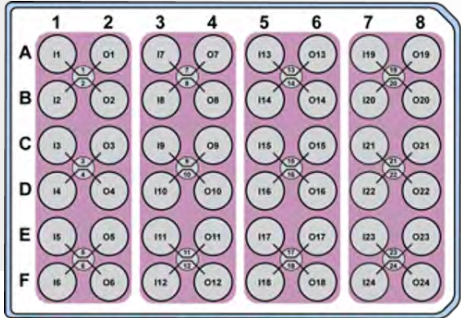
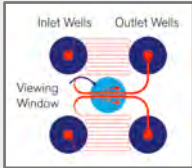

## 48-Well High Shear Plate

The 48-well high shear plate is excellent for experiments that need higher shear flow. The channels have been designed to reach a maximum shear stress of 200 dyne/cm<sup>2</sup> making them suited for platelet adhesion and aggregation assays, as well as other high shear applications.

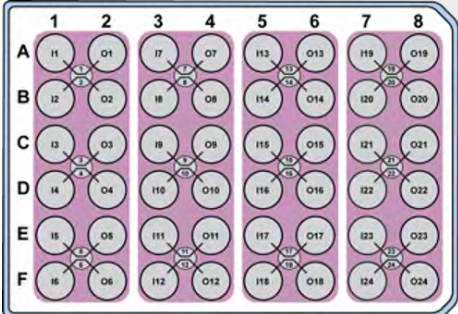
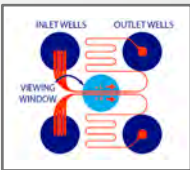

## 24-Well Low Shear Plate

The 24-well plate format is a low shear plate (up to 20 dyne/cm<sup>2</sup>). It features 8 experimental channels, each with two input wells that are controlled independently. Both inlet wells can also run simultaneously, creating two parallel liquid streams with a gradient at the juncture. Ideally suited for migration/invasion, wound healing, chemotactic gradients, compound screening.

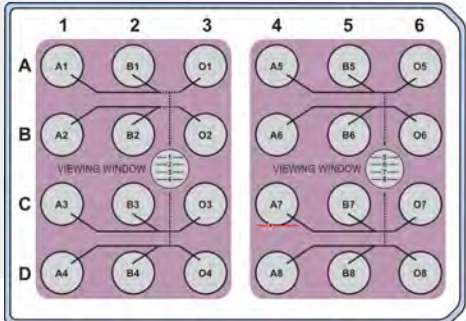
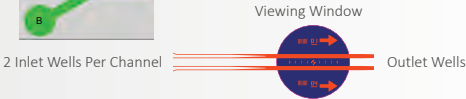
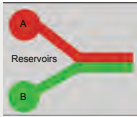

# PLATE COMPOSITION

## Standard Glass Bottom

The standard cover slip glass bottom is wonderful for high resolution live cell imaging. The bottom of the channels comprise 170µm coverslip glass which make them compatible with brightfield, phase, fluorescence and confocal microscopy.

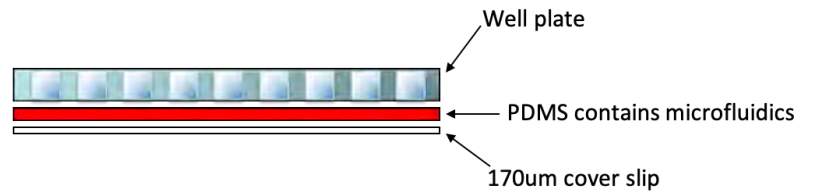

## PDMS Bottom

Polydimethylsiloxane (PDMS) is a key component of many medical devices due to superior biocompatibility and material stability. The formation of bacterial biofilms on these surfaces is an active area of research, due to the high importance of biofilms in medical device infections. The silicone bottom plates feature all-PDMS flow channels to address this need, and enable a full range of experimental protocols utilizing silicone substrates. Catheter infections can be modeled using primary media including human urine with BioFlux PDMS bottom plates.

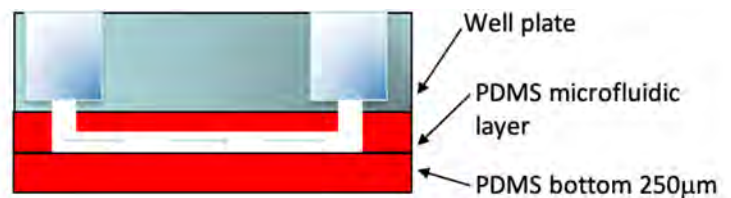

## Custom Substrate

Custom substrate plates feature the ability to add any material to the bottom of microfluidic flow chambers, and enable a full range of experimental protocols utilizing custom substrates. While the traditional glass bottom plates were developed to ensure immediate compatibility with a majority of imaging systems, these custom substrate plates maintain optical access while providing the user with a fully customizable growth surface.

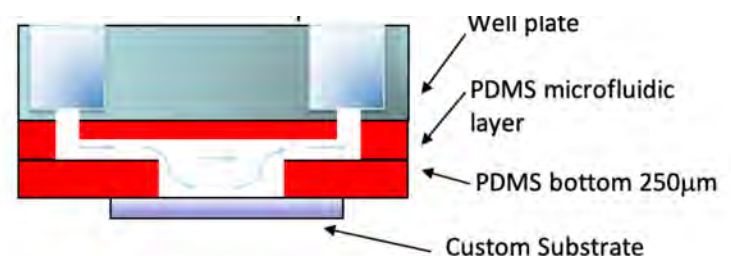

# KEY APPLICATIONS



## MICROBIOLOGY

In order to develop new solutions to combat biofilms, screening technologies must be designed to grow biofilms under conditions that mimic the physiological environment. BioFlux offers a comprehensive solution for running these biofilm assays under shear flow.

**Biofilm Growth — Antimicrobial Screening Host-Pathogen Interactions**



*Pseudomonas aeruginosa* biofilms grown under shear flow in the BioFlux microfluidic channels.

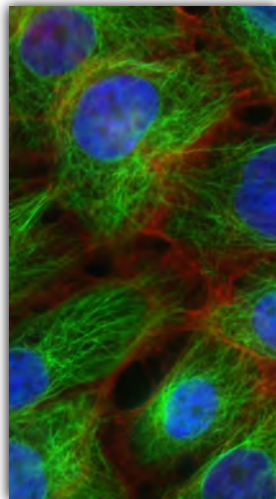

## IMMUNOLOGY

Immune surveillance in large part occurs within the vasculature in the presence of constant flow, where cell-cell and cell-ligand interactions are influenced by in situ forces. BioFlux provides the ability to control the timing and shear rate of these immune cell interactions.

**Cell Adhesion and Rolling — Wound Healing Transmigration — Migration**



*T-cells (Jurkat) attached to VCAM-1 under flow. Top = no-treatment control; bottom = anti-VLA4 treatment.*

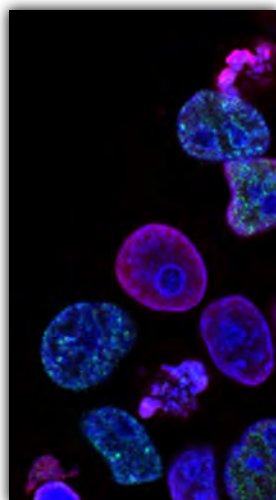

## ONCOLOGY

Understanding mechanisms of cancer progression is the key to development of successful treatments. BioFlux provides a physiologically-relevant in vitro model for studying cancer cell behavior by mimicking the vasculature under controlled shear flow conditions.

**Cancer Cell Adhesion and Rolling Metastasis — Cancer Cell Homing — EMT**

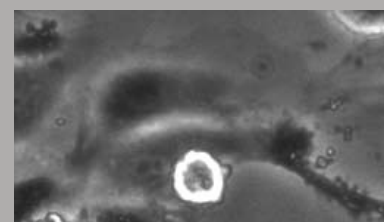

*A colon carcinoma cell (HT29) arrested on an endothelial cell under 0.8 dyne/cm<sup>2</sup> shear flow.*



# KEY APPLICATIONS

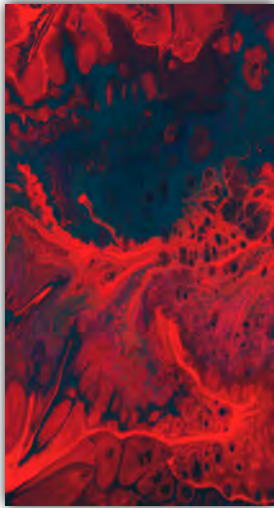

## VASCULAR BIOLOGY

Endothelial cells have been shown to alter their morphology and gene expression in the presence of the shear flow routinely seen in the vasculature. As such, the relevance of endothelial cell culture and downstream assays increases significantly with shear flow.

**Thrombosis — Atherosclerosis**  
**Migration and Invasion — Cell Adhesion**

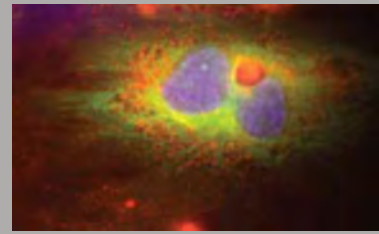

*A primary peripheral blood monocyte (red) attached to endothelial cells in the BioFlux system.*

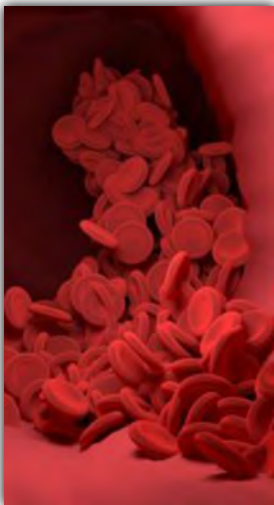

## PLATELET FUNCTION

Platelet activity is triggered in the presence of elevated shear and is dependent on many biochemical interactions present in blood. BioFlux enables simulation of vasculature shear flow using whole blood, platelet-rich plasma, or other cells of interest.

**Platelet Adhesion — Platelet Activation**  
**Platelet Aggregation — Platelet Rolling**

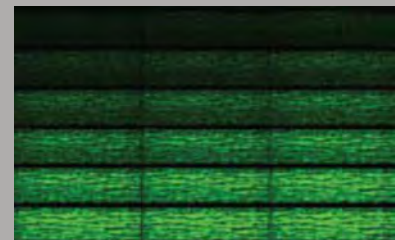

*Platelet aggregation on VWF under high shear for 10 minutes with calcein AM-labeled whole blood.*



## STEM CELLS

Applying controlled shear flow to undifferentiated ECSs promotes enhanced expansion of cell lines. Shear stress can be used as a stimulus for differentiation especially for cell types that naturally respond to physiological shear (e.g., endothelial cells).

**Controlled Differentiation —**  
**Bioproduction Mechanical Loading**

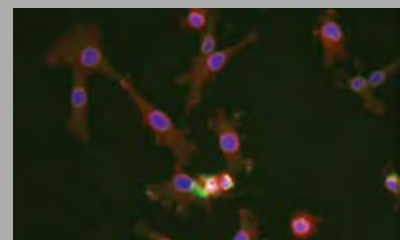

*Mesenchymal stem cells cultured under continual shear flow for 48 hours in the presence of VEGF.*

# THE BIOFLUX FAMILY

## BIOFLUX ONE

All the benefits of the industry-leading BioFlux cell analysis platform, in a configuration every lab can afford.

### Standard Features:

24 concurrent flow assays with single-phase flow control

Shear flow range from 0.5 to 200 dyne/cm<sup>2</sup>

Cell analysis software offering complete control over experimental conditions

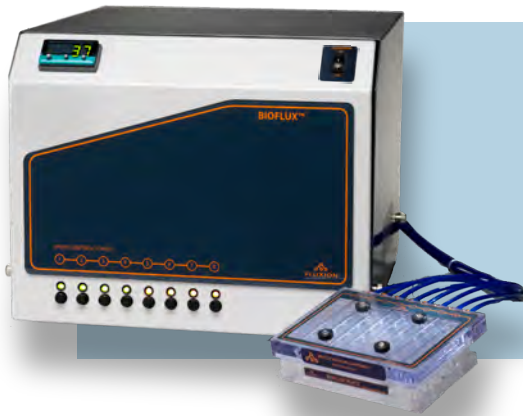

## BIOFLUX 200

The full-capability system for labs with an existing inverted microscope.

### Standard Features (in addition to above):

96 concurrent flow assays (with Quattro)

Two-phase flow for more complex experiments

Temperature control included

## BIOFLUX DCIS

The fully integrated digital cell imaging system designed to simplify demanding cell-based assays.

### Standard Features (in addition to those in BioFlux 200):

Fluorescent digital imaging system with automated stage

Dual CMOS cameras

Image acquisition and analysis software



## BIOFLUX 1000Z

The completely customizable BioFlux solution for ultimate imaging flexibility.

### Standard Features (in addition to those in BioFlux 200):

Custom automated microscope configuration

User-defined camera

Fully integrated control and analysis software (Montage)

# SYSTEM SPECIFICATIONS

System	BioFlux One	BioFlux 200	BioFlux DCIS	BioFlux 1000z
Throughput	24 flow assays	24 flow assays (96 with Quattro)	24 flow assays (96 with Quattro)	24 flow assays (96 with Quattro)
Fits in hood	✓	✓	✓	
Temperature control	Optional	✓	✓	✓
Plate formats	48-well	48-well 24-well (2 inlet)	48-well 24-well (2 inlet) 6-well	48-well 24-well (2 inlet) 6-well
Microscope	Use existing	Use existing	Standard configuration	Fully customizable
<i>Autofocus</i>			✓	✓
<i>Camera</i>			2 (monochrome and color)	User-defined
<i>Epifluorescence</i>			✓	✓
<i>Filter cubes</i>			DAPI, GFP, RFP	User-defined
<i>Motorized stage</i>			✓	✓
<i>Onstage incubator</i>			Optional	Optional enclosure
<i>Fluorescence</i>			4 channels	6 channels
<i>Objectives</i>			10X and 20X included, 5 positions total	10X and 20X included, 6 positions total
<i>Endpoint and live cell imaging</i>			✓	✓
<i>Automated plate scanning</i>			✓	✓
Cell analysis software	BioFlux Analysis software included Montage software optional	BioFlux Analysis software included Montage software optional	BioFlux Analysis software included Montage Offline software included	Integrated advanced control and analysis with Montage software
One-phase flow ( <i>biofilms, platelets, cell adhesion, etc.</i> )	✓	✓	✓	✓
Two-phase flow ( <i>chemotaxis, wound healing, migration, etc.</i> )		✓	✓	✓

# UPGRADES

## Environmental Control

Allows running the system with controlled gas (e.g., 5% CO<sub>2</sub>) rather than ambient. Ideal for long-term culture and for studying conditions such as hypoxia.

## Dual Gas

Allows 2 separate gas sources to be used to generate gas gradients or compare effects of different gas conditions on cell function.

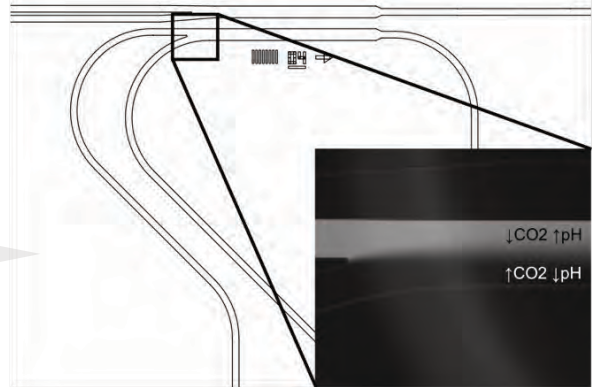

*Dual gas: the system uses two input wells to maintain a different gas concentration. CO<sub>2</sub> gas gradient induces a pH gradient that is detected via a pH-sensitive dye.*



## BioFlux Quattro

Achieve even higher speed in drug development under shear stress. BioFlux Quattro comprises a 4-plate array that connects to one BioFlux controller. With BioFlux Quattro, you can obtain quadruple your efficiency and decrease your experiment time while still keeping the ability to image plates on virtually any high content system (HCS) or automated microscope.

## Pulsatile Flow Module

Provides capability to mimic cardiovascular system flow.

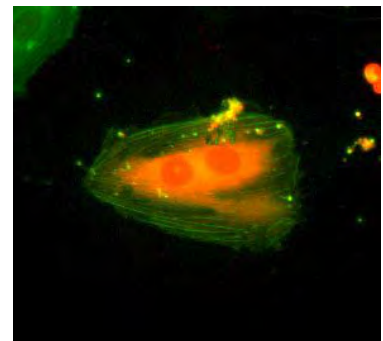
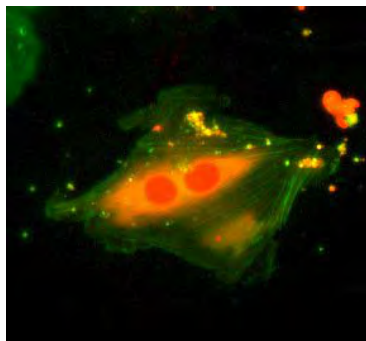
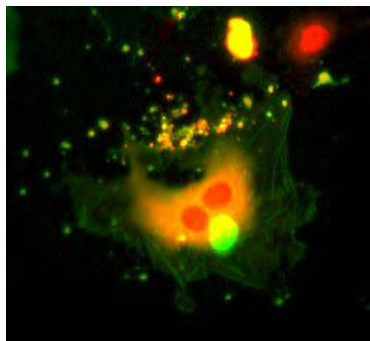

*The BioFlux system was used to apply pulsatile shear flow (amplitude 5 dyn/cm<sup>2</sup>, frequency 1.2 Hz) to endothelial cells transiently expressing actin-GFP constructs (green) and NLS-RFP, nucleus (red). Micrographs were captured every 30 minutes during the application of shear; shown (from left) are 0, 8.5, and 19 hr time points.*

# MONTAGE SOFTWARE

## Automated Experimental Control and Data Analysis

BioFlux Montage takes control of all microscopy hardware and image acquisition devices to produce high throughput, automated data from your BioFlux experiments. When it comes time for analysis, a comprehensive suite of analysis tools makes the process fast, simple, and powerful.

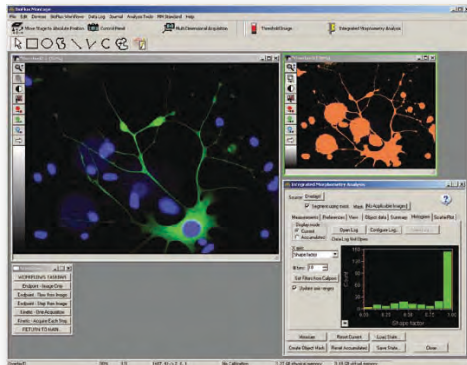

### BioFlux Montage

BioFlux Montage enables full hardware control, image acquisition, and data analysis. It features the BioFlux Control Module to synchronize BioFlux experiments with imaging data acquisition.

### BioFlux Montage Offline

BioFlux Montage Offline is a process-only software package which performs the full suite of Montage data analysis.

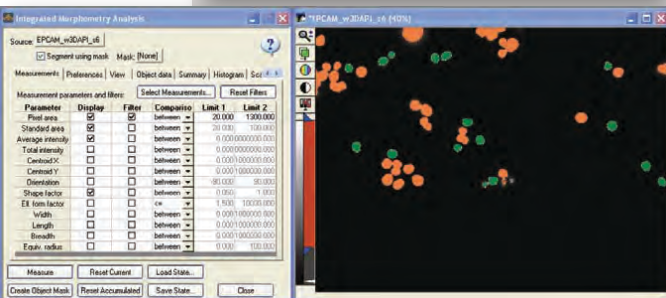

## Application Modules

### LIVE/DEAD

Used for assessing cell viability and is compatible with commercially available Live/Dead assay kits designed to study cell proliferation or death. Useful for cytotoxicity and apoptotic events.

### MULTI-WAVELENGTH SCORING

Enables scoring of individual cells for multi-parametric analyses. Useful for cytotoxicity and gene expression profiling.





### MULTI-DIMENSIONAL MOTION ANALYSIS

Tracks movement of individual cells or other cell related objects as they move across time-lapse image series. Useful for cell migration and invasion studies.

### NEURITE OUTGROWTH

Designed to measure and characterize outgrowths (length and branching), both of which are natural parts of neuronal development.



 fluxionbio.com  
 fluxionbio  
 fluxionbiosciences  
 fluxion-biosciences



# FLUXION

1600 Harbor Bay Parkway, #150  
Alameda, California, 94502  
United States of America

Toll Free: (866) 266-8380

Main: (650) 241-4777

Fax: (650) 873-3665

General: [info@fluxionbio.com](mailto:info@fluxionbio.com)

Sales: [sales@fluxionbio.com](mailto:sales@fluxionbio.com)

Orders: [orders@fluxionbio.com](mailto:orders@fluxionbio.com)

Support: [support@fluxionbio.com](mailto:support@fluxionbio.com)